

IRM-3 DUO

Rotary gas meter
G 400 - G 1000

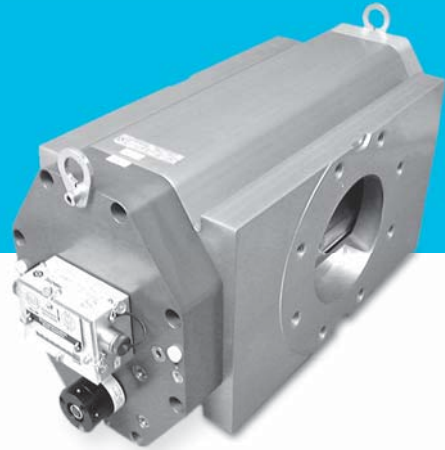

Applications

Media: Natural gas, town gas, inert gases
Industries: Gas industry, furnace construction, chemicals industry
Tasks: Measurement, control, regulation

Brief information

Operating principle: Elster-Instromet IRM-3 and IRM-3 DUO rotary gas meters are volumetric measuring devices for gaseous media which operate according to the positive displacement principle. They record the operating volume. Electronic volume correctors can be used in order to correct the volume to the standard volume. IRM-3 DUO meters operate with two phase-shifted pairs of impellers which create two separate units of measurement. Pulsations are thereby eliminated, which are generated by conventional rotary gas meters. This leads to an extremely quiet, resonance-free and almost silent operation of these meters. The number of revolutions is proportional to the measured volume. The rotation is transferred to a mechanical index via a gear assembly and the volume is then recorded.

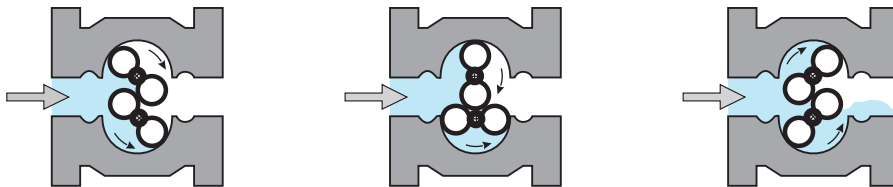

Conformity: IRM-3 DUO meters are designed, produced and tested in accordance with the following directives:

- EC Directive 2004/22/EC (MID)
- EC Directive 97/23/EC concerning pressure equipment (PED)
- EC Directive 94/9/EC concerning explosion protection (ATEX)

General: Rotary gas meters are characterised by a high measuring range and a compact design. Due to their measuring principle, they do not require a straight inlet or outlet pipe section. In order to guarantee long service life, the rotary gas meters are lubricated with oil. The standard double index allows the meter to be adapted to any flow direction.

Main features

- Meter sizes: G 400 – G 1000
- Flow rates from 6 to 1600 m³/h
- Nominal sizes DN 100 – DN 200
- Pressure ratings
PN 10/16 and ANSI 150
- Temperature ranges:
MID: -25 °C to +55 °C
PED: -25 °C to +55 °C
ATEX: -20 °C to +55 °C
- Aluminium housing
- DUO principle for pulsation-free, resonance-free and low-noise operation
- Double index for universal installation and flow direction
- Optional: Absolute-ENCODER S1D
- Optional: Mechanical index drive

IRM-3 DUO: Rotary gas meters G 400 - G 1000

Technical data	
Operating pressure	Max. 16 bar
Protection class	IP44: Meter with universal index, ventilated IP65: Meter with universal index, closed IP67: Meter with Absolute-ENCODER index SID
Housing	Aluminium, piston made of Aluminium
Metrological approvals	PTB, domestic approval 7.131-99.14, NMI EEC E234-J, NMI MID T10198
ATEX approval	Ex II 2 Gc IIC T6, according to ATEX directive 94/9/EC
Media	Natural gas, town gas, inert gases; other gases on request
Max. error ± 1 % for $Q_t - Q_{max}$ ± 2 % for $Q_{min} - Q_t$	$Q_t = 0.2 \quad Q_{max}$, for measuring range $\leq 1:20$ $Q_t = 0.15 \quad Q_{max}$, for measuring range $> 1:30$ $Q_t = 0.1 \quad Q_{max}$, for measuring range $= 1:50$ $Q_t = 0.05 \quad Q_{max}$, for measuring range $> 1:50$
Reproducibility	< 0.1%
Applicable standards	OIML R137-1 (MID), ANSI B109.3 (PED), EN 13463-1 and 5 (ATEX)
Index variants	Double index (standard) Multi Index (option) Absolute-ENCODER SID (option)
Outputs	- 2 LF pulse generators (reed contact) - 1 HF pulse generator (option), not possible with integrated Absolute-ENCODER index SID (direct mounting on housing cover)
Pressure/temperature tapping	2 pressure tapings 1/4" NPT, 2 thermowells standard

Measuring ranges according to PTB approval								
Size	Nominal diameter	Measuring range		Q_{min} [m ³ /h]		Q_{max} [m ³ /h]	Measuring volume dm ³	HF* [imp/m ³]
		national	EC approval	national	EC approval		DUO	option
G 400	100/150	1 : 100	1 : 20	6	32.0	650	5.530	720
G 650	150	1 : 160	1 : 20	6	50.0	1000	8.849	450
G 1000	200	1 : 160	1 : 20	10.0	80.0	1600	14.180	282

* Stated HF pulse values nominal, specific values may differ

Universal index



Flow direction: left - right
respectively. top - bottom

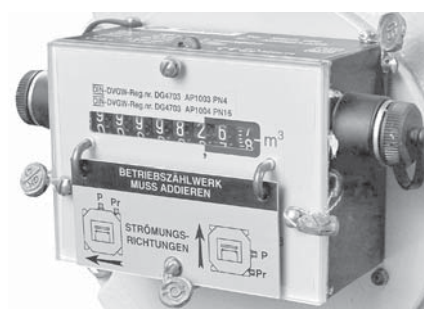

Flow direction: right - left
respectively. bottom - top

DUO principle

The meters of sizes G 400 - G 1000 have two phase-shifted pairs of impellers (DUO), which form two separate units of measurement. The pulsations of both measurement units eliminate each other. The result is an extremely quiet operation without resonance and pulsations. The resulting additional enhanced measurement characteristic allows the use of these meters as a test rig master meter with a high measuring range.

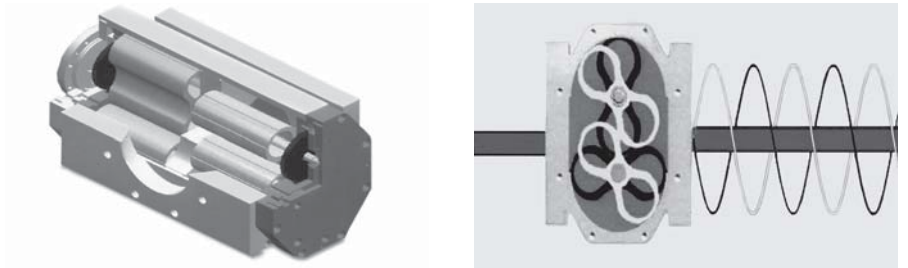

IRM 3 DUO G 1000 version

The IRM-3 DUO G 1000 DN200 is adapted to DN200 using the appropriate fittings.

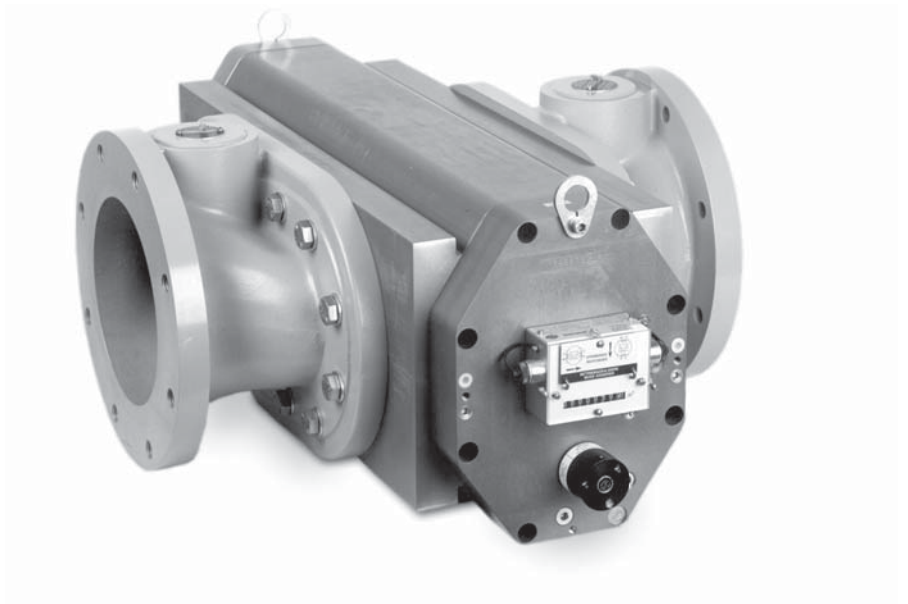

Absolute-ENCODER index SID

- Electronically readable mechanical double index
- PTB and ATEX approval
- Various data interfaces available

Detailed information can be found on the data sheet "Absolute-ENCODER S1"

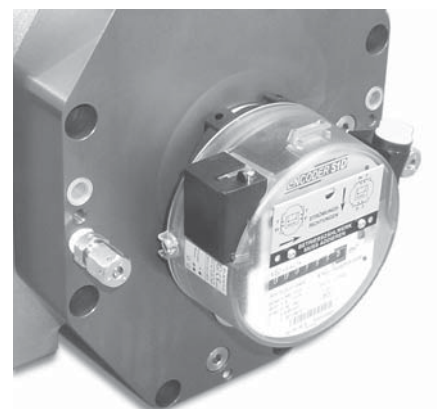

IRM-3 DUO: Rotary gas meters G 400 - G 1000

Dimensions and Weights

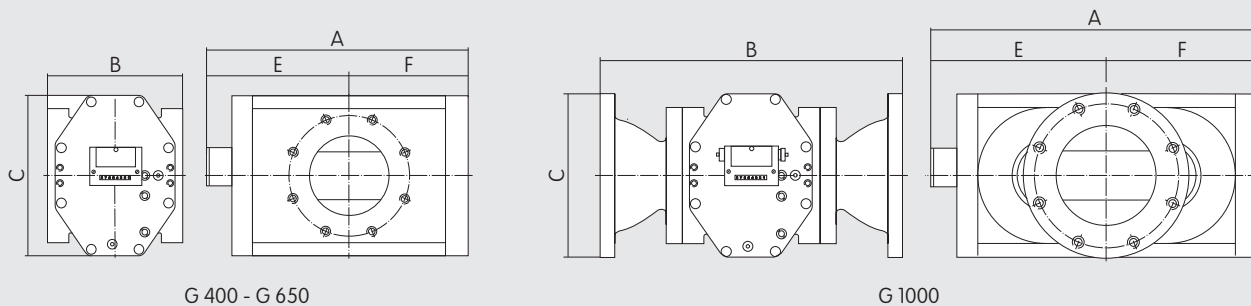

Size	Nominal diameter	Dimensions					Weight [kg]
		A	B	C	E	F	
G 400	100/150	466	241/260	308	270	196	46/50
G 650	150	598	260	308	336	262	62
G 1000	200	810	600	340	442	368	113

Pressure loss

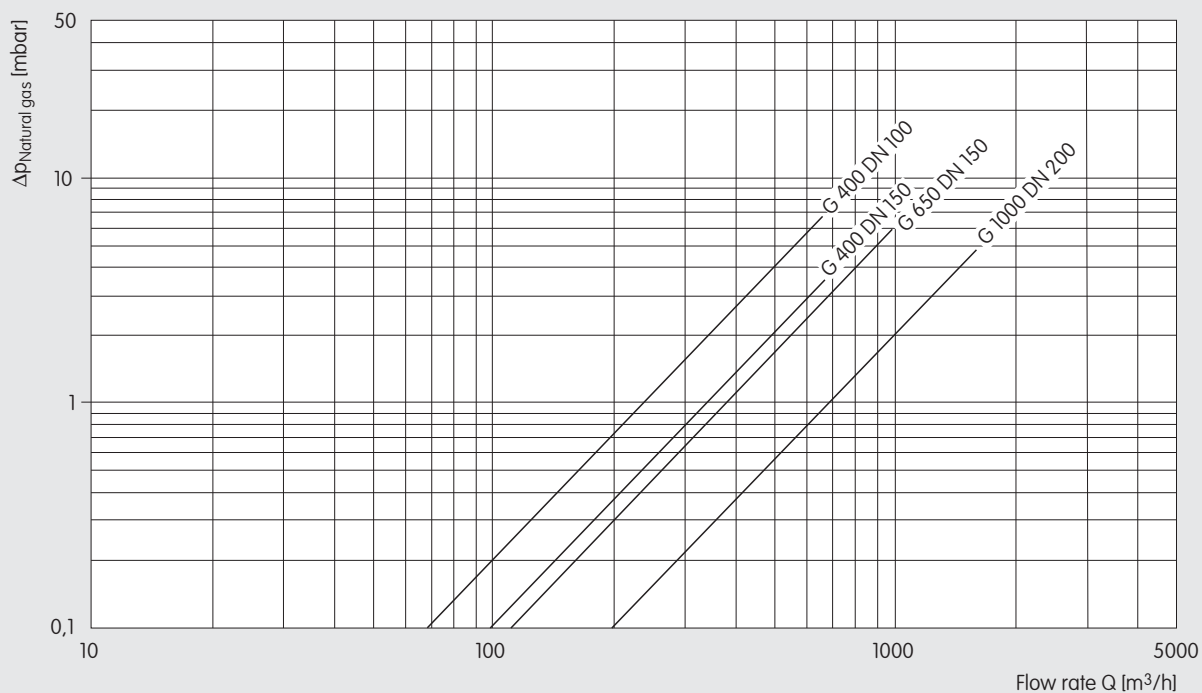

The pressure loss values refer to natural gas (0.8 kg/m³) at atmospheric pressure. When using natural gas at higher operating pressures, these values must be multiplied by the absolute pressure (in bar).

Your contacts

Germany
 Elster GmbH
 Steinern Str. 19 - 21
 55252 Mainz-Kastel
 T +49 6134 605 0
 F +49 6134 605 223
www.elster-instromet.com
info@elster-instromet.com

Belgium
 Elster-Instromet N.V.
 Rijkmakerlaan 9
 2910 Essen
 T +32 3 670 0700
 F +32 3 667 6940
www.elster-instromet.com
info@elster-instromet.com

Singapore
 Elster-Instromet Sdn. Bhd. (Singapore Branch)
 160 Paya Lebar Road
 #04-01 Orion@Paya Lebar
 Singapore 409022
 T +65 6247 7728
 F +65 6247 7729
sales@elster-instromet.com.sg

IRM 3 EN02

A28.06.2010