

Static Heat and Cooling Meter T450
Residential; local and district heating

Landis+Gyr+
manage energy better

ULTRAHEAT®T450 ULTRACOLD®T450



Service manual
32 21 101 004 a
Date: 22.04.2020
© Landis+Gyr GmbH

Contents

| | |
|--|-----------|
| Contents | 2 |
| 1 General notes | 4 |
| 1.1 Other available documentation | 4 |
| 1.2 Safety information | 5 |
| 2 Operating elements | 7 |
| 3 Parameterization | 7 |
| 3.1 Calling the parameterization function | 7 |
| 3.2 Setting of parameters | 7 |
| 4 Adjustable parameters | 8 |
| 4.1 Delete error F8 | 9 |
| 4.2 Delete maxima, minima and average values | 9 |
| 4.3 Delete error- and volume measurement time | 10 |
| 4.4 Enter yearly set date | 10 |
| 4.5 Enter monthly set date | 10 |
| 4.6 Enter mid-month set date | 10 |
| 4.7 Switch time of set date | 11 |
| 4.8 Enter date | 11 |
| 4.9 Enter time | 11 |
| 4.10 Enter property number | 12 |
| 4.11 Enter M-Bus secondary address | 12 |
| 4.12 Enter M-Bus primary address | 12 |
| 4.13 Test communication function | 13 |
| 4.14 Switch radio module on / off | 13 |
| 4.15 Switch unit of heat quantity | 14 |
| 4.16 Change the installation location of the volume measuring part | 14 |
| 4.17 Switch temperature sensor Pt100 to Pt500 | 15 |
| 4.18 Switch to normal operation | 15 |
| 5 Torques | 15 |
| 6 Power supply | 15 |
| 6.1 Changing the battery | 15 |
| 6.2 Dynamical calculation of battery life | 16 |
| 7 Communication module | 16 |
| 7.1 Connection terminals | 17 |
| 7.2 Pulse output module | 18 |
| 7.2.1 Installing the communication | 18 |
| 7.2.2 Testing of the module | 19 |
| 7.3 M-Bus module | 19 |
| 7.3.1 Installing the communication | 19 |
| 7.4 Radio-module 868 MHz (Wireless M-Bus) | 20 |
| 7.4.1 Installing the communication | 20 |
| 7.4.2 Start transmission mode | 20 |
| 7.4.3 Start transmission mode using LOOP 2 | 21 |
| 7.4.4 Start/stop transmission mode using parameterization mode | 21 |
| 7.4.5 Testing of the module | 21 |
| 8 Pulse inputs | 21 |
| 8.1 Connection of pulse inputs | 21 |
| 8.2 Activation of pulse inputs | 22 |
| 9 Replacement of detachable temperature sensors | 22 |

| | |
|---|-----------|
| 10 Firmware update | 23 |
| 10.1 System requirements | 23 |
| 10.2 Perform firmware update | 23 |
| 10.3 Checking the actualized firmware version | 24 |
| 11 Service software UltraAssist | 24 |

1 General notes



Note: In the following text, the term "meter" is used to refer to both the heating meter as well as the cooling meter unless otherwise stated.

The meter has left the factory in a technically safe condition. Only personnel, trained in the installation and operation of meters in heating and cooling systems, may execute any kind of manual work relevant for the device, like the adjustment, maintenance or replacement of single components part of the meter. Further technical support is provided by the manufacturer on request. The meter's calibration-relevant security symbols must not be damaged or removed. Otherwise, the warranty and calibration validity of the meter will be invalidated.

1.1 Other available documentation

- Operating instructions T450
- Installation instructions T450
- Technical description T450
- Respective module manual
- List of accessories

Additional information is available on request.

1.2 Safety information

The following safety regulations must always be observed:



The meters may only be used in building installations and only for the applications described.



The local regulations (installation, etc.) must be observed.



The operating conditions on the nameplate must be observed during use. Failure to comply with these regulations can cause dangerous situations and voids all claims arising from liability for defects as well as liability based on any expressly granted guarantees.



Comply with the requirements for circulation water (CEN / TR 16911:2016).



The meter is only suitable for circulation water in heating systems.



The meter is not suitable for drinking water.



Do not lift the meter on the calculator.



Pay attention to sharp edges on threads, flanges and the measuring tube.



Only personnel trained in the installation and operation of meters in heating/cooling systems may install and remove the meter.



Only install or remove the meter on an unpressurised system.



After installing the meter, check the leak tightness of the system.



Breaking the safety marks relevant for calibration voids the warranty and the validity of the calibration.



Avoid contact of the meter housing with silicone oils or substances containing silicone oil.



Only clean the meter from the outside with a soft, slightly moistened cloth. Do not use spirits or cleaning agents.



The meter must not be energized until it has been fully assembled. Otherwise there is a risk of electric shock on the terminals. A defective or obviously damaged device must be disconnected from the power supply immediately and replaced.



The meter is valid for disposal as waste electronic equipment within the meaning of the European Directive 2012/19/EU (WEEE) and must not be disposed of as household waste. The corresponding national and legal regulations must be observed, and the device must be disposed of via the channels provided for this purpose. The local and currently valid legislation must be observed.



The meter contains lithium batteries. Do not dispose of the meter and batteries as household waste. Observe local regulations and laws regarding disposal.



After lithium batteries have been used, you can return them to the manufacturer for proper disposal. When shipping batteries please

observe legal regulations which among other things govern the labelling and packaging of hazardous goods.



Do not open the batteries. Do not bring batteries into contact with water or expose to temperatures exceeding 80 °C.



The meter has no lightning protection. Ensure lightning protection via the house installation.

2 Operating elements

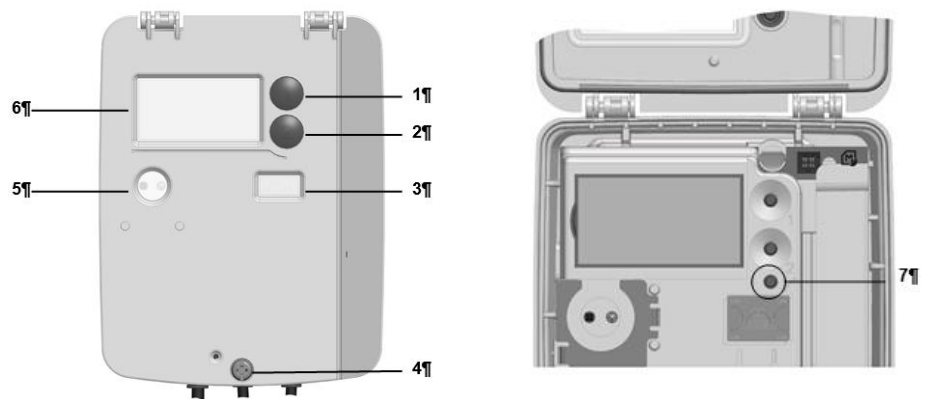

Fig. 1: Operating elements

| No. | Name | Description | Note |
|-----|-------------------|--|--------------------------------------|
| 1 | Button 1 | Switches to the next display value within a loop. | |
| 2 | Button 2 | Switches to the next loop. | |
| 3 | Security seal | | |
| 4 | Screw | | |
| 5 | Optical interface | Permits data communication via a computer with the necessary service software. | |
| 6 | LCD | | |
| 7 | Service button | To call up the parametrization operation of the meter. | Accessible after removing the cover. |

3 Parameterization



Note: The parameterization of the meter may have an impact on the battery life.



Note: Alternatively, the meter can be parameterized in the parametrization mode via the optical interface using UltraAssist.

3.1 Calling the parameterization function

Proceed as follows to parameterize the meter:

- Press the service button for 3 seconds until the LCD displays

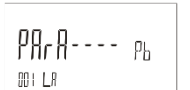

- Press button 2 to adjust the parameterization.

3.2 Setting of parameters

To select a parameter, proceed as follows:

- Press button 1 to advance the display.
- Press button 2 to activate the parameter to be changed.

4 Adjustable parameters



Note: The functions of the module can also be parameterized without an installed module.

The following parameters of the meter can be set:

| LCD display | Description | Notes |
|-------------|---|--|
| | Delete error F8 | |
| | Delete maxima, minima and average values | |
| | Delete error- and volume measurement time | |
| | Enter yearly set date (DD, MM) | Enter options: day 01-31; month 01-12 |
| | Enter monthly set date (DD) | Enter options: day 01-31 |
| | Enter mid-month set date (DD) | Enter options: day 01-31 |
| | Switch time of set date | Options: 24 (end of day); 00 (start of day) |
| | Enter date (DD, MM, JJ) | Entry options: day 01-31; month 01-12; year 00-99 |
| | Enter time (hh, mm, ss) | Entry options: Hour 00-23; Minute 00-59; Second 00-59 |
| | Enter property number | Entry options: per digit 0-9 |
| | Enter M-Bus secondary address | Entry options: per digit 0-9 |
| | Enter M-Bus primary address | Entry options: 000-250 |
| | Test communication function | |
| | Switch radio module on / off | |
| | Switch unit of heat quantity | Only displayed when activated in the factory. |
| | Change the installation location of the volume measuring part | Only displayed when activated in the factory. |

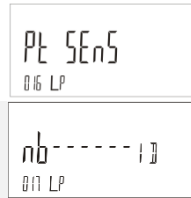

Switch temperature sensor
Pt100 to Pt500

Only displayed when
activated in the factory.

Switch to normal operation

4.1 Delete error F8

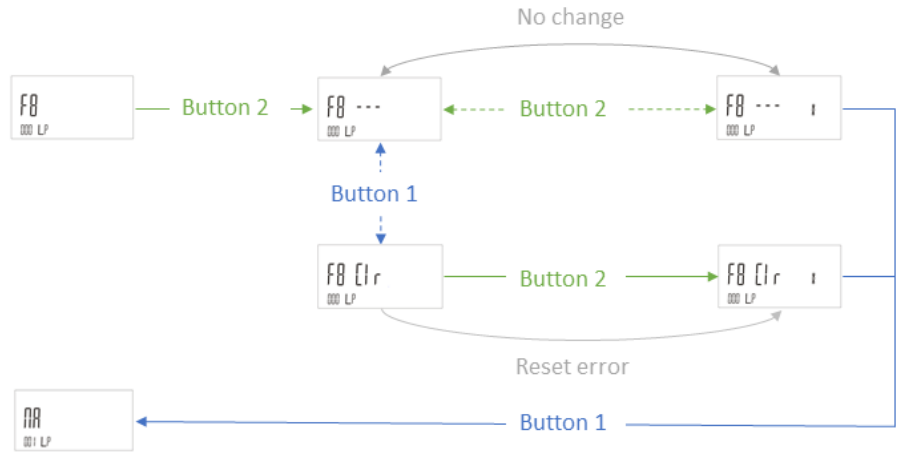

4.2 Delete maxima, minima and average values

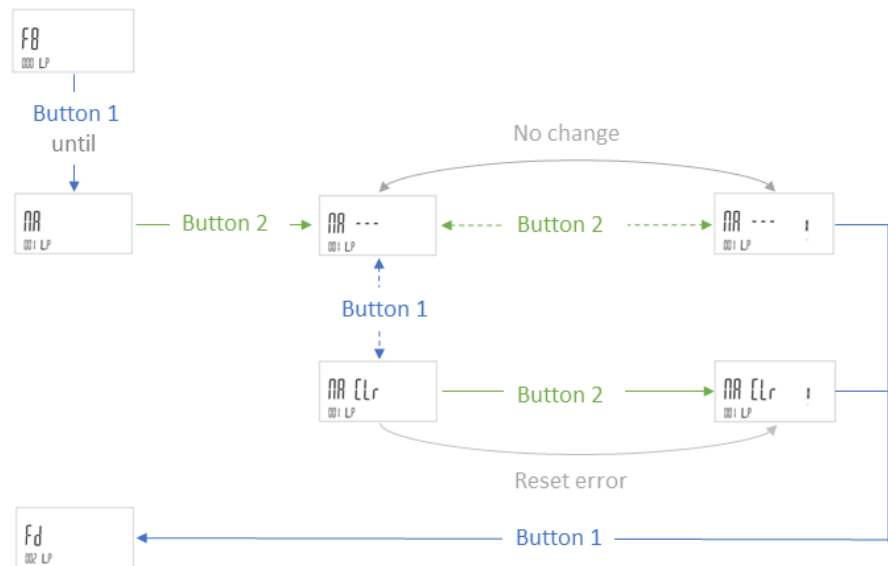

4.3 Delete error- and volume measurement time

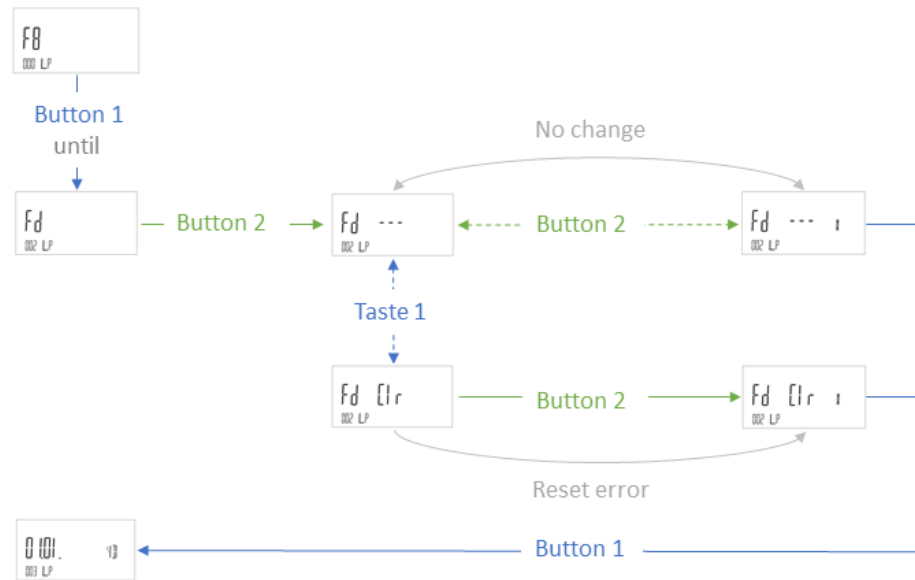

4.4 Enter yearly set date

To enter the yearly set date, proceed as follows:



1. Press button 1 repeatedly until the LCD displays .
2. Press button 2 repeatedly until the digit to be modified begins to flash.
3. Press button 1 repeatedly until the required value is being displayed on the LCD.

Step 2 and 3 can be optionally repeated as often as needed until the required value is being indicated.

4. Press button 1 to finally confirm the entered value. Please note that no digit may flash any more.

4.5 Enter monthly set date

To enter the monthly set date, proceed as follows:

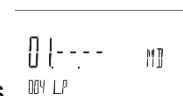

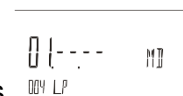
1. Press button 1 repeatedly until the LCD displays .
2. Press button 2 repeatedly until the digit to be modified begins to flash.
3. Press button 1 repeatedly until the required value is being displayed on the LCD.

Step 2 and 3 can be optionally repeated as often as needed until the required value is being indicated.

4. Press button 1 to finally confirm the entered value. Please note that no digit may flash any more.

4.6 Enter mid-month set date

To enter the mid-month set date, proceed as follows:

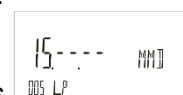

1. Press button 1 repeatedly until the LCD displays .
2. Press button 2 repeatedly until the digit to be modified begins to flash.

- Press button 1 repeatedly until the required value is being displayed on the LCD.

Step 2 and 3 can be optionally repeated as often as needed until the required value is being indicated.

- Press button 1 to finally confirm the entered value. Please note that no digit may flash any more.

4.7 Switch time of set date

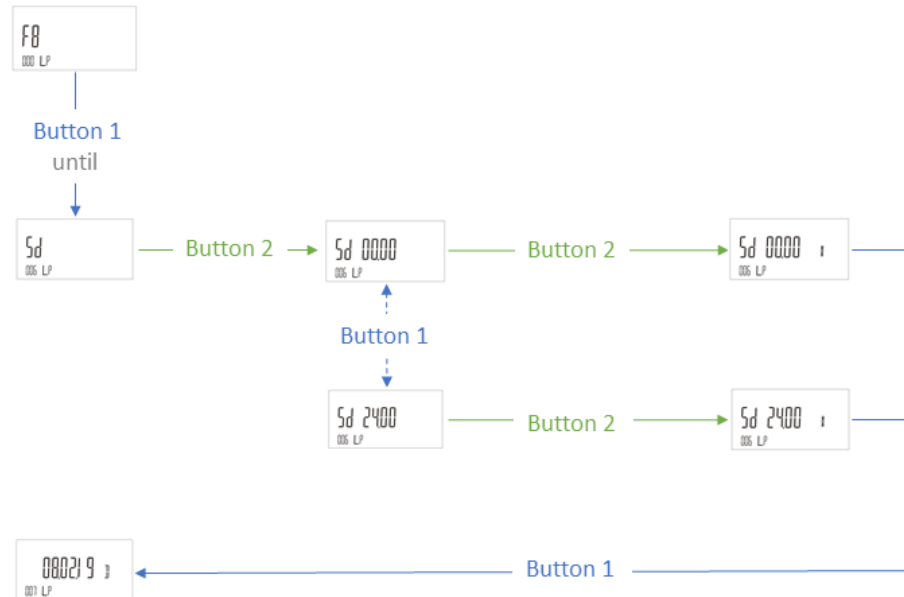

4.8 Enter date

To enter the date, proceed as follows:

- Press button 1 repeatedly until the LCD displays .
- Press button 2 repeatedly until the digit to be modified begins to flash.
- Press button 1 repeatedly until the required value is being displayed on the LCD.

Step 2 and 3 can be optionally repeated as often as needed until the required value is being indicated.

- Press button 1 to finally confirm the entered value. Please note that no digit may flash any more.

4.9 Enter time

To enter the time, proceed as follows:

- Press button 1 repeatedly until the LCD displays .
- Press button 2 repeatedly until the digit to be modified begins to flash.
- Press button 1 repeatedly until the required value is being displayed on the LCD.

Step 2 and 3 can be optionally repeated as often as needed until the required value is being indicated.

4. Press button 1 to finally confirm the entered value. Please note that no digit may flash any more.

4.10 Enter property number

To enter the property number, proceed as follows:

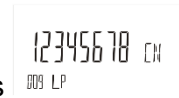

1. Press button 1 repeatedly until the LCD displays
2. Press button 2 repeatedly until the digit to be modified begins to flash.
3. Press button 1 repeatedly until the required value is being displayed on the LCD.

Step 2 and 3 can be optionally repeated as often as needed until the required value is being indicated.

4. Press button 1 to finally confirm the entered value. Please note that no digit may flash any more.

4.11 Enter M-Bus secondary address

To enter the M-Bus secondary address, proceed as follows:



1. Press button 1 repeatedly until the LCD displays
2. Press button 2 repeatedly until the digit to be modified begins to flash.
3. Press button 1 repeatedly until the required value is being displayed on the LCD.

You can repeat steps 2 and 3 as many times as you want until the required value appears.

4. To confirm the entered value, press the button 1, making sure that no more digits are flashing.

4.12 Enter M-Bus primary address

To enter the M-Bus primary address, proceed as follows:



1. Press button 1 repeatedly until the LCD displays
2. Press button 2 repeatedly until the digit you want to modified flashes.
3. Press button 1 repeatedly until the required value is being displayed on the LCD.

You can repeat steps 2 and 3 as many times as you want until the required value appears.

4. To confirm the entered value, press the button 1, making sure that no more digits are flashing.

4.13 Test communication function

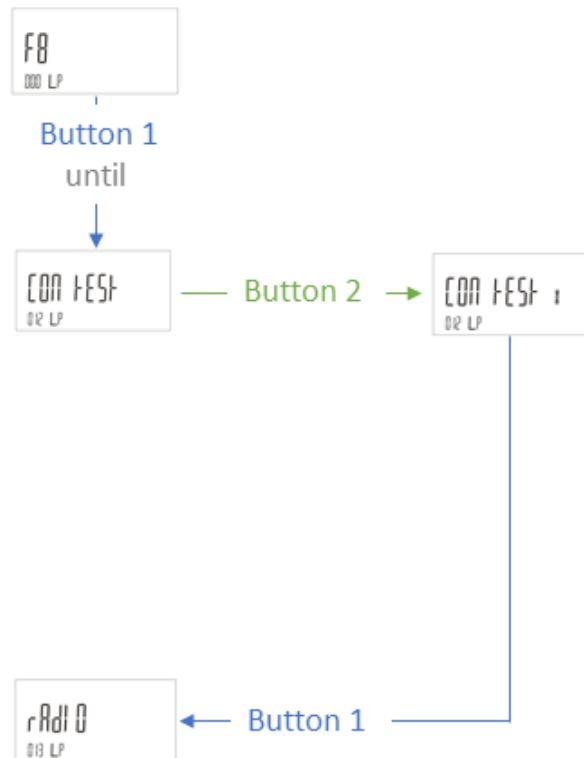

4.14 Switch radio module on / off

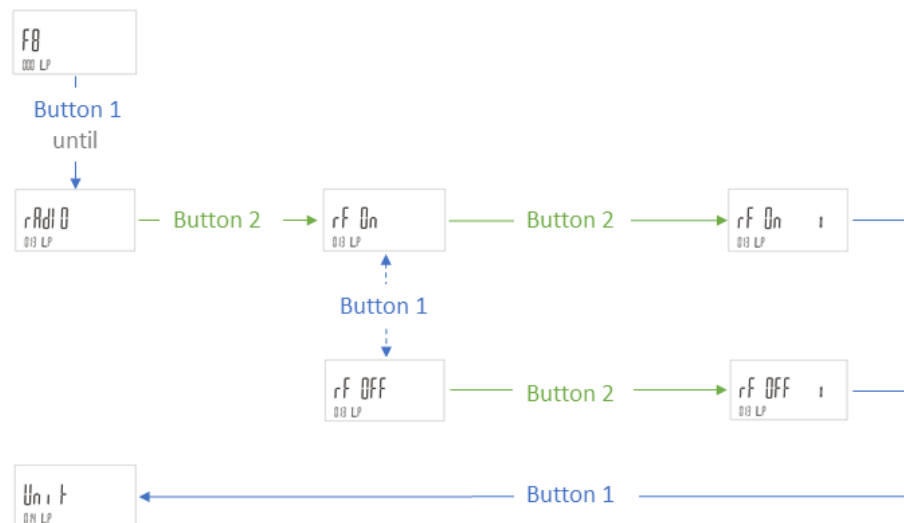

4.15 Switch unit of heat quantity

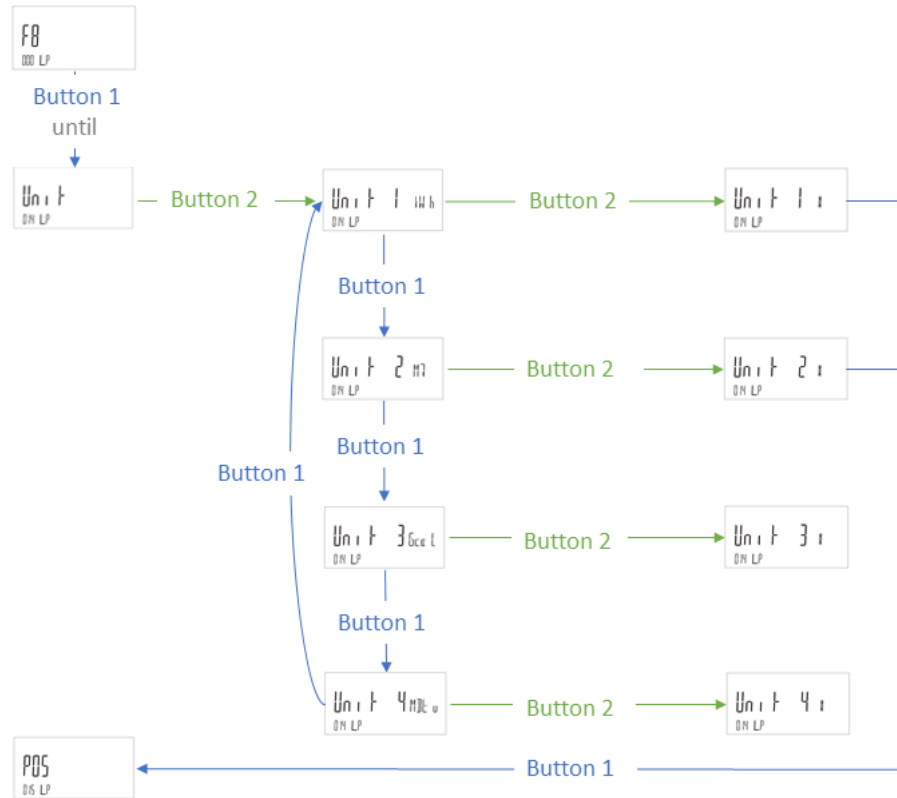

4.16 Change the installation location of the volume measuring part

Note: If necessary, adjust the temperature sensors according to the installation requirements.

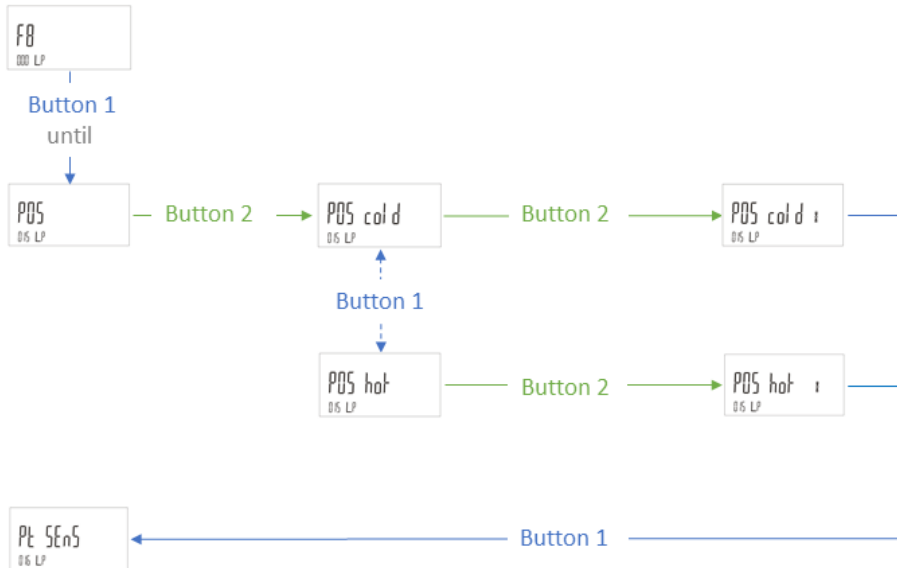

4.17 Switch temperature sensor Pt100 to Pt500

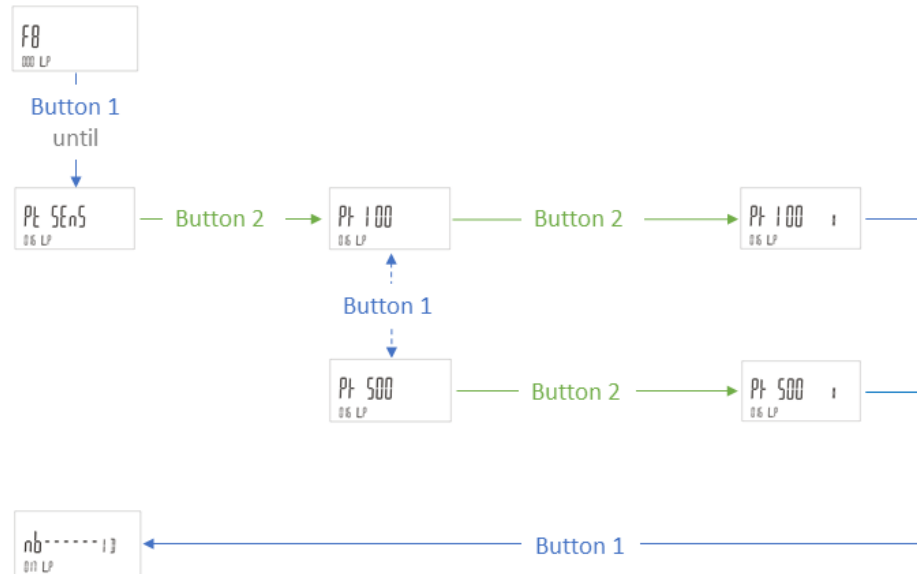

4.18 Switch to normal operation

To switch into normal operation, proceed as follows:

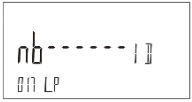
- Press button 1 repeatedly until the LCD displays .
- To switch into normal operation switch button 2.

5 Torques

Please note the following torques for tightening the screws and nuts on the meter:

- Screw on the device cover (Fig. 1, No. 4): min. 1 Nm
- All other screws: Hand-tightened to approx. 0.5 Nm

6 Power supply



Caution: Do not open the batteries. Do not bring batteries into contact with water or expose to temperatures exceeding 80 °C. Dispose of used batteries at suitable collection points.

6.1 Changing the battery



Note: When replacing the battery, ensure that the battery service life is longer than the planned life cycle of the meter.



Note: Only batteries approved by the manufacturer may be installed.



Note: After lithium batteries have been used, you can return them to the manufacturer for proper disposal. When shipping batteries please observe legal regulations which among other things govern the labelling and packaging of hazardous goods.

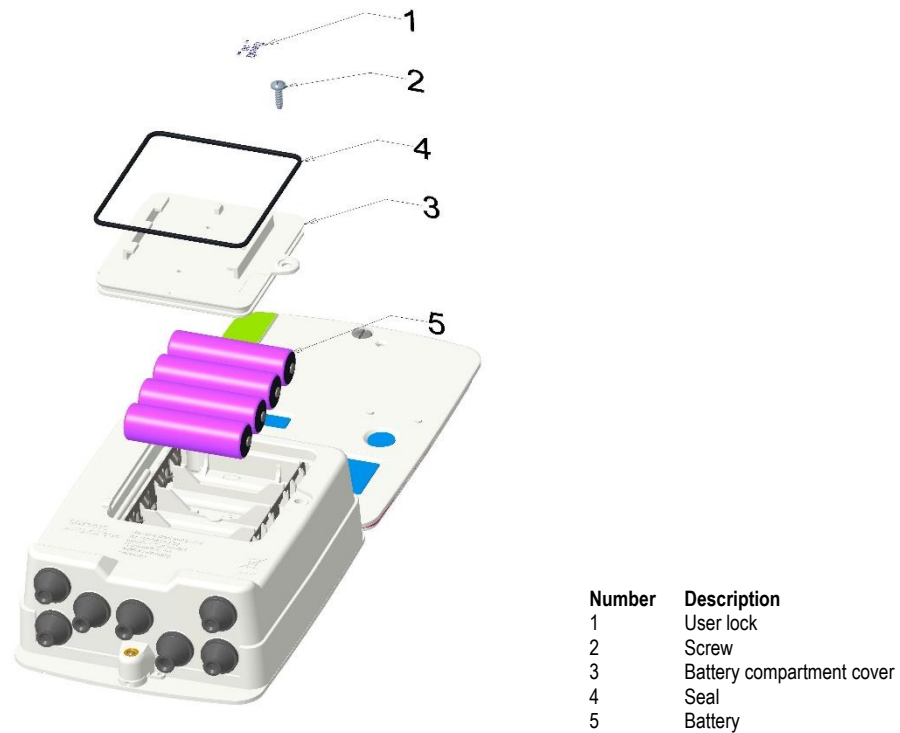

Fig. 2: Battery compartment

To change the battery, proceed as follows:

- If necessary, open the battery compartment cover by loosening the screw.
- Remove the old batteries from the battery compartment.
- Insert the battery into the battery compartment according to the polarity mark. Observe the connection sequence. Always start with the labelled battery position 1.
- Close the battery cover by tightening the screw.
- If necessary, attach a user lock to the battery cover.
- Set the number of new batteries via UltraAssist.

6.2 Dynamical calculation of battery life



Note: Note that after changing the batteries, the number of batteries must be parameterized via UltraAssist. This ensures that the meter can calculate the battery life correctly.

7 Communication module



Note: Observe the required ESD protection measures when installing modules.

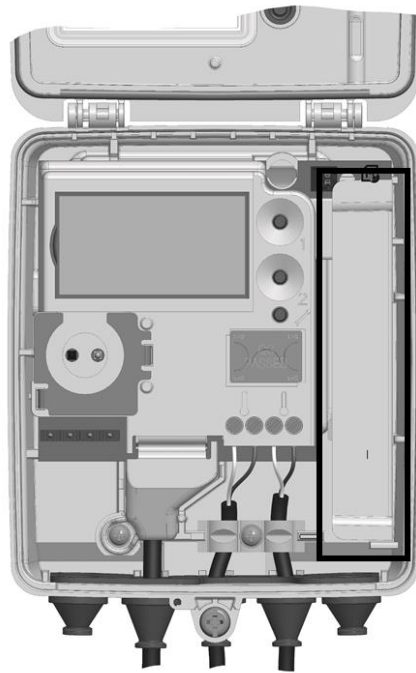

Fig. 3: Module slot

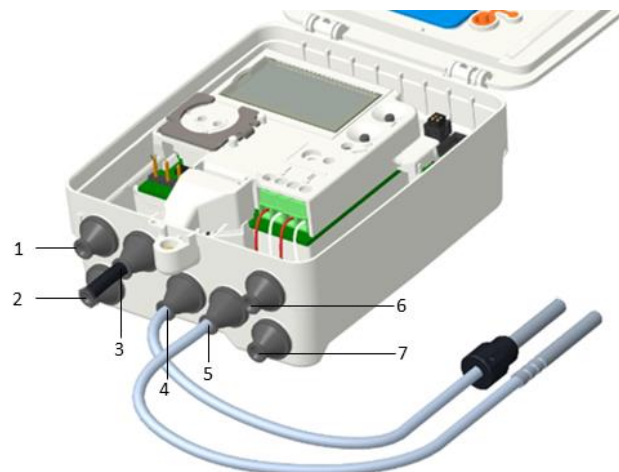

Fig. 4: Grommets

7.1 Connection terminals

2-pole or 4-pole terminals are used for connection of the external cables to the modules.

- Stripping length 6 mm
- Connection capacity
 - rigid or flexible, 0.14 ... 1.5 mm²
 - flexible with wire and ferrule with plastic sleeve, 0.25 ... 1.5 mm²
 - flexible with wire end ferrule without plastic sleeve, 0.25 ... 1.0 mm²
 - conductor sizes 26 ... 14 AWG
- Recommended screwdriver:
 - 0.6 × 3.5 mm
- Tightening torque: 0.35 ... 0.4 Nm

7.2 Pulse output module



Note: The output mode as well as standard or high-resolution pulses can be parameterized via UltraAssist.



Note: The connections on the pulse output module are protected against polarity reversal.

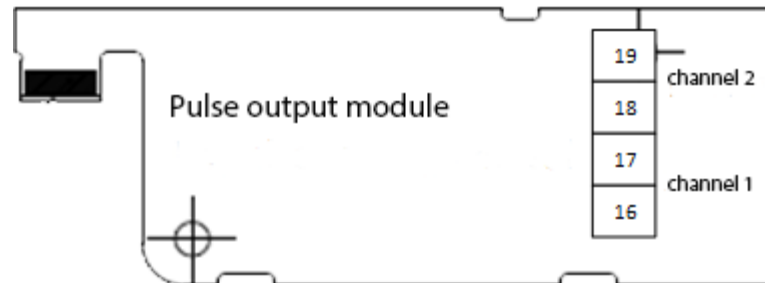

Fig. 5: Pulse output module

On channel 1 (terminal 16, 17):

- energy (CE)
 - volume (CV) or
 - tariff register 1 (C1)
- pulses can be output.

On channel 2 (terminal 18, 19):

- volume (CV)
 - tariff register 1 (C1) or
 - tariff register 2 (C2)
- pulses can be output.

The pulse duration is identical on both channels.

Standard pulses are set to

- 100 ms pulse duration and
- 1 kWh / 1 MJ or 10 l.

High-definition pulses are set to

- 10 ms pulse duration and
- 0.1 kWh / 0.1 MJ or 1 l.

7.2.1 Installing the communication

Proceed as follows to install a communication module:

- If necessary, open the housing cover by loosening the screw.
- Run the cable from the outside through the grommet.
- Strip and connect the cable.
- Secure the cable with the strain relief clamp.
- Connect the cable to the module's terminals.
- Pull the cables out through the housing while inserting the module.
- First attach the contact surfaces of the module to the module slot.

- Gently push the module in.
- Close the housing cover by tightening the screw (see chapter Torques) and press the housing cover tightly into place.

Depending on the design of the housing, please also observe the following points:

- For IP 68 versions of the housing, tighten the cable gland.
- For the IP54 version of the housing, make sure that the grommet is seated correctly.



Note: Please find the technical details and technical data of the communication modules in their documentation.



Note: No later than 60 seconds after installation, the meter automatically  detects the inserted modules and is ready for communication or pulse output.

7.2.2 Testing of the module



The  function in the parameter setting mode of the meter forces a pulse output on both channels.

Please find further information on the testing of the module in chapter 4.13.



Note: Each further pressing of button 2 causes a pulse forces a pulse on both channels.

7.3 M-Bus module



Note: The telegram content of the readout can be parameterized via UltraAssist.

The M-Bus module T45-MBUS enables the meter to communicate with a M-Bus center in order to transmit measured values.

7.3.1 Installing the communication

Proceed as follows to install a communication module:

- If necessary, open the housing cover by loosening the screw.
- Run the cable from the outside through the grommet.
- Strip and connect the cable.
- Secure the cable with the strain relief clamp.
- Connect the cables to one of the terminals (24 and 25) of the module. Another M-Bus meter can be connected to the free terminals (24 and 25).
- Pull the cables out through the housing while inserting the module.
- First attach the contact surfaces of the module to the module slot.
- Gently push the module in.
- Close the housing cover by tightening the screw (see chapter Torques) and press the housing cover tightly into place.

Depending on the design of the housing, please also observe the following points:

- For IP 68 versions of the housing, tighten the cable gland.
- For the IP54 version of the housing, make sure that the grommet is seated correctly.



Note: Please find the technical details and technical data of the communication modules in their documentation.



Note: No later than 60 seconds after installation, the meter automatically  detects the inserted modules and is ready for communication.

7.4 Radio-module 868 MHz (Wireless M-Bus)

The wireless M-Bus function enables the meter to communicate with a stationary unit or a mobile unit using 868 MHz radio frequency.

The module supports the OMS¹-compliant data transfer including an individual encryption function.

7.4.1 Installing the communication

The communication modules are connected via a non-reactive plug, so that installation or modification is possible at any time.



Note: Touch the module only on its plastic holder.



Note: To connect an external cable, open the cable sleeves so that they tightly enclose the cable.

Proceed as follows to install a communication module:

- If necessary, open the housing cover by loosening the screw.
- First attach the contact surfaces of the module to the module slot.
- Gently push the module in.
- Close the housing cover by tightening the screw (see chapter Torques) and press the housing cover tightly into place.

Depending on the design of the housing, please also observe the following points:

- For IP 68 versions of the housing, tighten the cable gland.
- For the IP54 version of the housing, make sure that the grommet is seated correctly.



Note: Please find the technical details and technical data of the communication modules in their documentation m.



Note: No later than 60 seconds after installation, the meter automatically  detects the inserted modules and is ready for communication.

7.4.2 Start transmission mode



The following options are available to start the transmission mode:

¹ Open Metering System

- Start transmission mode using LOOP 2
- Start transmission mode using parameterization mode
- Start transmission mode via UltraAssist. Please have a detailed look at the UltraAssist manual.

7.4.3 Start transmission mode using LOOP 2

Proceed as follow to start the transmission mode:

- Press button 2 repeatedly until the LCD displays .
- Press button 1 repeatedly until the LCD displays .
- Press button 2 long (more than 3 s).

The transmission mode is activated, and the LCD display changes to



The meter immediately starts sending the data telegram regularly.

7.4.4 Start/stop transmission mode using parameterization mode

Please find more detailed information on starting and stopping the transmission mode by means of the parameterization mode in chapter **Fehler! Verweisquelle konnte nicht gefunden werden..**

7.4.5 Testing of the module



The **CON TEST** function in parameter setting mode of the meter forces a radio transmission.

Please find more detailed information on the testing of the transmission mode in chapter 4.13.



Note: Each further pressing of button 2 updates the send data of the data telegram by transmission from the meter and sends a radio telegram.

8 Pulse inputs



Note: It is recommended to use the pulse input set T45-PULSE-IN for the connection.

The meter has 2 pulse inputs for cumulating volume pulses from external devices, for example a domestic cold-water meter and / or hot water meter.

The pulse inputs can be read out via the 868 MHz radio module, the M-Bus module or the optical interface.

The meter readings of the pulse inputs are also indicated on the LCD.

8.1 Connection of pulse inputs

For the connection of pulse inputs, proceed as follows:

- If necessary, open the housing cover by loosening the screw.

- Guide the cable from the outside through the grommet 1 or 2 (see Fig. 4).
- Strip the cable.
- Secure the cable with the strain relief clamp.
- Connect the impulse lines to the terminal.
- While inserting the terminal, pull the cables through the housing to the outside.
- Close the housing cover by tightening the screw and press on the housing cover firmly.

Depending on the design of the housing, please also observe the following points:

- For IP 68 versions of the housing, tighten the cable gland.
- For the IP54 version of the housing, make sure that the cable gland fits correctly.

8.2 Activation of pulse inputs



Note: The pulse inputs need to be activated via UltraAssist.

Please note the following points for activation:

- The pulse input is activated by entering the pulse value.
- The pulse value of the input must match the pulse value of the output.
- Use the device numbers of the water meters for activation.

Please note the following points for activation of pulse inputs:

- The primary addresses and the secondary addresses or the device numbers must each be individual.
- By assigning the addresses, the pulse inputs can be queried individually with their own data frame.
- The current volume meter reading of the pulse inputs is also contained in the standard data frame.

9 Replacement of detachable temperature sensors



Note: If removable temperature sensors are used, they must have their own calibration or certificate of conformity.



Note: The maximum cable length of the temperature sensors is 10 m. An extension is not permitted.

Proceed as follows to replace the detachable temperature sensors:

- If necessary, open the housing cover by loosening the screw.
- If necessary, loosen the existing temperature sensors at the connection terminals with a suitable wrench.
- If necessary, remove the existing temperature sensors from the housing.
- Run the warm side temperature sensor cable from the outside through the 4th grommet from the left and the cold side temperature sensor of the through the 5th grommet from the left (see Fig. 4).

- Strip both cables as shown in the figure 6.

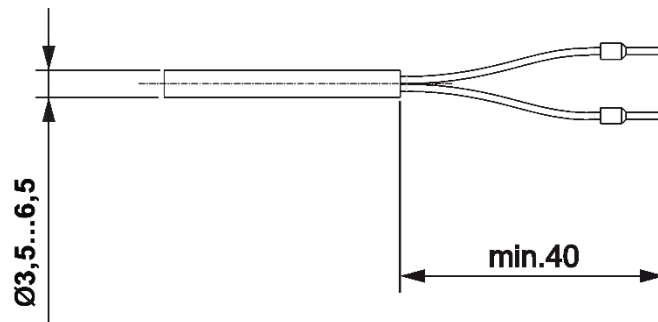



Fig. 6: Temperature sensor connection

- Connect the wires according to the printed wiring diagram. The connection is made to terminals 5/6 (warm side temperature sensor) and 7/8 (cold side temperature sensor).
- Insert the temperature sensors into the thermowells, ball valves or T-pieces. The temperature sensor must sit on the bottom of the thermowell.
- Seal the temperature sensors to prevent manipulation.
- Close the housing cover by tightening the screw (see chapter Torques) and press the housing cover tightly into place.

If the LCD displays , you can reset this error message via the parameterization menu. See chapter 4.1.



10 Firmware update

10.1 System requirements

In order to perform the firmware update, you need the following tools:

- UltraAssist software as of version 2.07.00
- Optical head
- Firmware image file

10.2 Perform firmware update

- Open the housing cover of the meter by loosening the screw.
- Press the service button for approx. 3 sec., until  is indicated.
- Place the optical head on the optical interface.
- Start the UltraAssist software.
- Click on the  icon.

The following meter information appears (example):

Heat meter UH40 (Version 20.02 / 20.02) in Pb (with calibration seal) found.

6. Open the following menu: PARAMETERIZATION → LEGALLY RELEVANT PARAMETERS

The following window appears:



7. Click on "Load new firmware image".

A dialog for selecting the firmware image file appears.

8. Open the firmware image file.

UltraAssist automatically checks the firmware image file and the "OK" button is selectable.

9. To perform the firmware update, click the "OK" button.

As a result, UltraAssist performs a firmware update (approximately 4 minutes duration).

After successfully updating the firmware, click "Close".

10.3 Checking the actualized firmware version

You can check the updated firmware version and the checksum in Loop 0.

| | |
|-----|------------------|
| | Head of the loop |
| ... | |
| | Firmware version |
| | CRC / CMAC |

11 Service software UltraAssist

The meter may also be parameterized in the parameterization mode using the optical interface via UltraAssist.

Contact:

Landis+Gyr GmbH
Humboldtstraße 64
90459 Nürnberg
Germany
www.landisgyr.eu

Landis+
Gyr
manage energy better